

|                     |
|---------------------|
| SHDSL.bis and Fiber |
| Up to 300Mbps       |
| Ethernet            |

# Orion MiniFlex

## SHDSL.bis and Optical Mini DSLAM



### Features

- Up to 15.2Mbps Data Transmission per Copper Pair
- SHDSL and SHDSL.bis, TC-PAM16/32
- Additional TC-PAM4/8/64/128 Available
- 100 / 1000 Mbps Fiber Optical Tributary Interface
- Integrated Layer 2 Managed Ethernet Switch:
  - 4x Gigabit Ethernet Uplink (2x TP / 2x SFP)
  - 8x 10/100Mbps
- Rapid Spanning Tree, Ethernet Ring Protection, Link Aggregation, VLAN, QoS
- Transparent Transmission of Modbus RTU / ASCII, DNP3 and IEC 60870.5 Protocol
- Point-to-Point, Point-to-Multipoint & Ring Operation
- Console Port, Telnet, Web, SNMP Management
- 24/48VDC and/or 110/230VAC Redundant Powered, Low Power Consumption
- Included Primary Protection
- Repeater supported and available
- 19" & 2U Height or Robust DIN-Rail Metal Enclosure
- Industrial Temperature Range Available

Orion Telecom Networks, Inc's **MiniFlex** platform is a special part of the **Orion3** product family. Beside having up to 10 dual **Orion3 SHDSL.bis Extended** line cards there is a feature-rich managed layer 2 Ethernet switch included. This switch has 8 auto-sensing front accessible 10/100Base-T ports as well as 2 gigabit Ethernet ports with fiber connectivity (SFP) and 2 gigabit Ethernet ports with copper connectivity (RJ-45). The inside backplane connects this switch to all Orion3 line cards through additional 10 Ethernet 10/100 Base-T ports.

The Orion3 SHDSL.bis Extended product family offers a broad range of products, which are based on the latest SHDSL.bis standards (ITU-T G.991.2 & ETS TS 101 524), while also being fully interoperable with all our existing SHDSL equipment (Orion1 & Orion2).

SHDSL.bis Extended allows symmetrical data transmission at speeds up to 15.2Mbps over a single pair of copper. In addition, the dual Orion3 line card also supports DSL channel bonding for 2 copper pairs in order to achieve speeds to 30.4Mbps! Using the link aggregation feature of the additional integrated switch, the Orion MiniFlex can transmit up to 300Mbps over 20 copper pairs. This incredible speed makes Fiber installations in a lot of places needless.

In addition to SHDSL.bis, the **MiniFlex** platform supports subscriber access over Fiber Optic. The optical line card has built-in SFP jack for standard 100 or 1000 Mbps Ethernet module. The protocol is compatible with third-party switches, media converters, etc. Like all Orion products, the MiniFlex and its line cards are based on industrial components and are manufactured according to highest quality standards providing additional value due to the extended temperature range and higher reliability. The combination of comprehensive functions providing maximum flexibility together with the higher quality of the MiniFlex makes it the perfect choice for your access needs.

**Possible Application: Point-to-Point & Point-to-Multipoint**

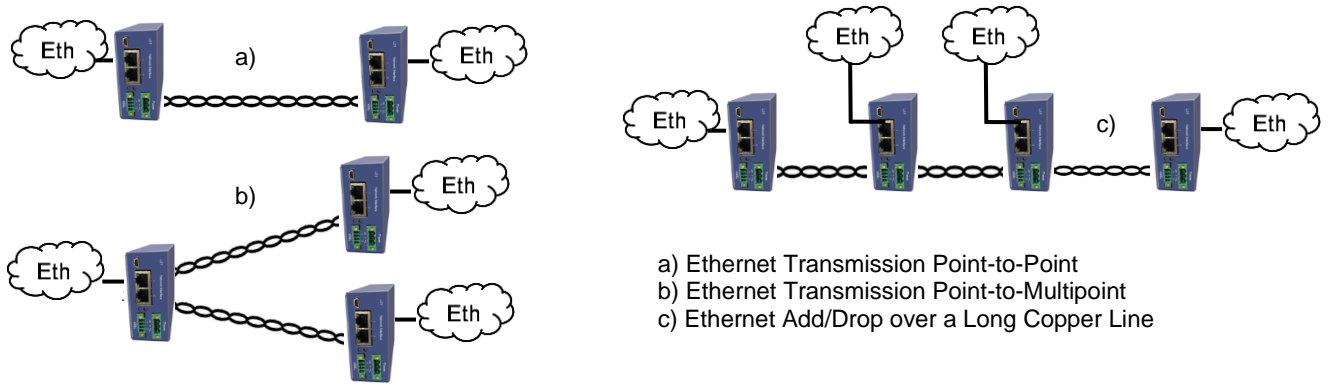

a) Ethernet Transmission Point-to-Point  
 b) Ethernet Transmission Point-to-Multipoint  
 c) Ethernet Add/Drop over a Long Copper Line

**Possible Application: Typical Internet Service Provider (ISP) Application**

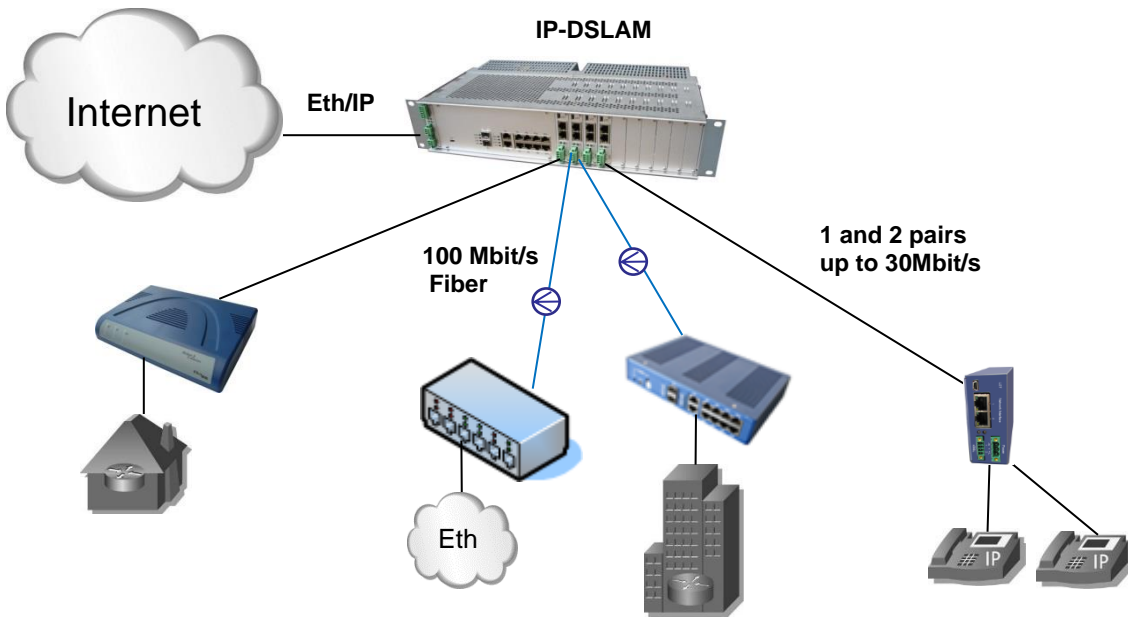

**Possible Application: Ring with the 19" MiniFlex Racks**

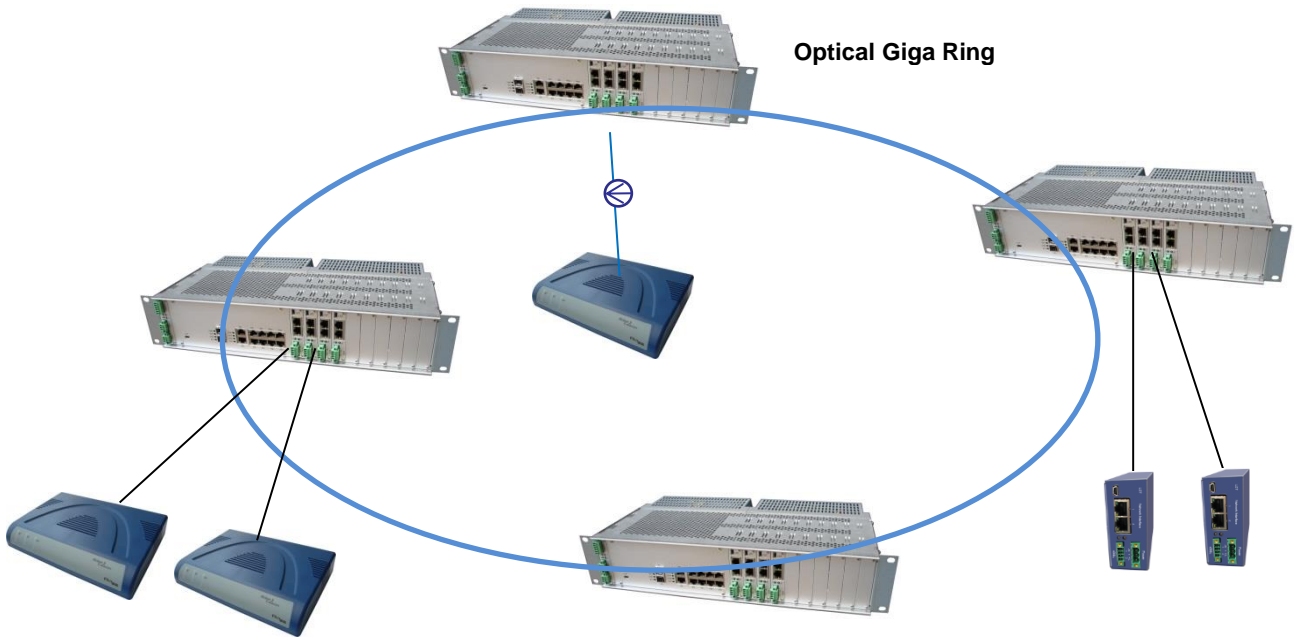

**Possible Application: Ring with the MiniFlex Dinrail Modems**

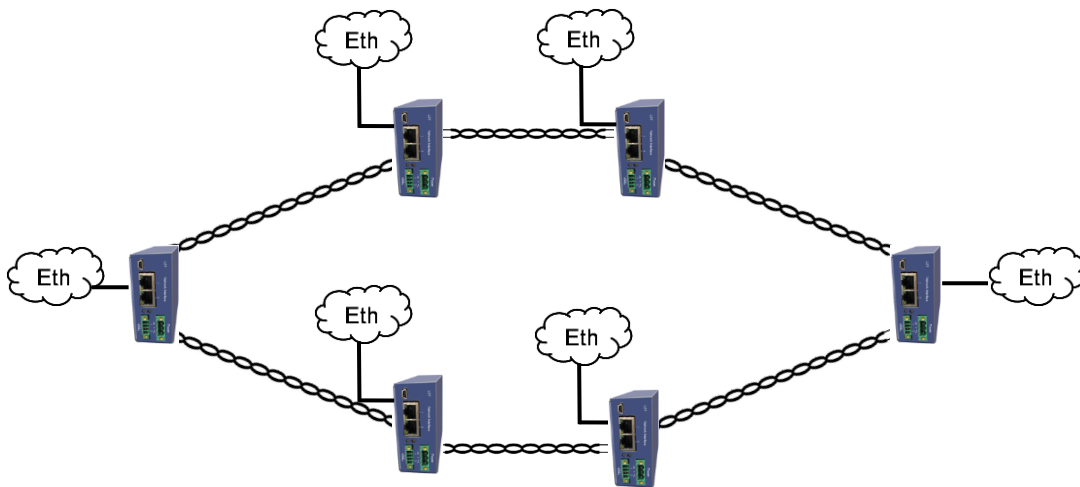

## MiniFlex Rack with included Switch for 10 Linecards



### Model: MF-MR2N-SW-12Eth,V2

- Switch Interfaces: 8x Ethernet 10/100BaseT (Auto Sensing)  
2x Gigabit Ethernet 1000Base-T  
2x Gigabit Ethernet SFP  
1x USB 2.0 (Local Consol Port)  
10x Ethernet 10/100BaseT on Backplane to Line Card
- Physical Interfaces: SFP cage, RJ45 (Ethernet), Mini-B (USB)
- Management: Local Console Port, Telnet/SSH, Web, SNMP v1 and V2c
- L2 Features: **Spanning Tree and Ethernet Ring**  
IEEE 802.1D Spanning Tree Protocol (STP)  
IEEE 802.1w Rapid Spanning Tree Protocol (RSTP)  
IEEE 802.1s Multiple Spanning Tree Protocol (MSTP)  
Ethernet Ring Protection Mechanism, 50ms rapid In switching and  
**VLAN**  
4K IEEE 802.1q VLANs  
Port-based VLAN, MAC-Based VLAN, Private VLAN  
GVRP, Q-in-Q, VLAN Translation  
**Link Aggregation**  
Static Trunk, Dynamic Trunk, IEEE 802.3ad LACP, Load  
**Multicast Features**  
IGMP v1, v2, v3, IGMP Snooping, IGMP Groups  
Multicast VLAN
- QoS: **Quality of Service**  
8 Priority Queues/port  
WRR, Strict Priority  
WRR/WDDR+Strict Priority  
802.1p  
Port-Based CoS  
CoS based on MAC DA/SA  
Bandwidth Control per Port  
**Access Control List**  
MAC+Port Binding, VLAN+Port Binding
- Security: **Port Security**  
Trust Port, Port Blocking, Private VLAN, Port Powering Off  
MAC address learning limit per port  
DoS check, Management IP list
- Alarm Interface: Major and Minor Alarm Relays



### Model: MF-MR2N-SW-8Eth,V2

- Switch Interfaces: 6x Ethernet 10/100/1000BaseT (Auto Sensing)  
2x Ethernet 1000Base-X or 2500Base-X (SFP)  
1x USB 2.0 (Local Consol Port)  
10x Ethernet 10/100/1000BaseT on Backplane to Line Card
- Physical Interfaces: SFP cage, RJ45 (Ethernet), Mini-B (USB)
- Management: Console Port, Telnet, SSH, HTTP, HTTPS, SNMPv1/v2c/v3, SD-Card support
- Indication: Major and Minor Alarm LEDs & Power Supply Detection LEDs
- L2 Features: IEEE-802.3, VLAN IEEE-802.1Q, QoS IEEE-802.1P  
STP IEEE 802.1D
- Alarm Interface: Major and Minor Alarm Relays

## MiniFlex Rack without Switch for 10 Linecards

### Model: MF-MR2N,V2

- Alarm Interface: Major and Minor Alarm Relays



## Power Supply for MiniFlex Rack

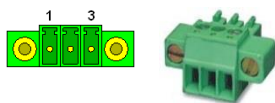

### Model: MF-PS48, V1

Input Voltage: 18 - 72 VDC, max. 90 Watts  
Temperature: -20 to +70°C  
Connector: 3 Pin Phoenix Mini Combicon connector (Front access)



### Model: MF-PS110/230, V1

Input Voltage: 90 - 264 VAC, 47 - 63 Hz, max. 90 Watts  
Temperature: -20 to +70°C  
Connector: IEC 60320 Appliance Inlet C14 (Back access)

## MiniFlex FlatRack with included Switch for 5 Linecards



### Model: MF-FR05N-SW-2Eth,V1

Modes: MDI / MDI-X auto crossover, Auto Negotiation, Full/Half Duplex  
Interfaces: 1x Ethernet 1000Base-X or 2500Base-X (SFP) on the back panel  
1x Ethernet 10/100/1000BaseT on the back panel  
7x Ethernet 10/100/1000BaseT on Backplane to the Line Cards  
Physical Interfaces: SFP cage, RJ45 (Ethernet), Mini-B (USB)  
Management: Console Port, Telnet, SSH, HTTP, HTTPs, SNMPv1/v2c/v3, SD-Card support  
Indication: Major and Minor Alarm LEDs & Power Supply Detection LEDs  
L2 Features: IEEE-802.3, VLAN IEEE-802.1Q, QoS IEEE-802.1P  
STP IEEE 802.1D  
Size: 483x293x24mm (WxLxH)

## MiniFlex FlatRack without Switch for 5 Linecards



### Model: MF-FR05N,V1

Size: 483x293x24mm (WxLxH)

## Power Supply for MiniFlex FlatRack



### Model: MF-PS48-FR05N,V1

Input Voltage: 18 - 72 VDC, max. 40 Watts  
Temperature: -20 to +60°C (at full load)  
Connector: 3 Pin Phoenix Combicon connector (Back access)

### Model: MF-PS230-FR05N,V1

Input Voltage: 170 - 264 VAC, 47 - 63 Hz, max. 60 Watts  
Temperature: -20 to +60°C  
Connector: 3 Pin Phoenix Combicon connector (Back access)

### Model: MF-PS120-FR05N,V1

Input Voltage: 85 - 132 VAC, 47 - 63 Hz, max. 60 Watts  
Temperature: -20 to +60°C  
Connector: 3 Pin Phoenix Combicon connector (Back access)



### MiniFlex MiniRack 2U for 4 Linecards

**Model:** MF-MR-RAIL-2U4S,V2

- Input Voltage: 18 - 72 VDC, max. 20 Watts, Dual Input, Fuse 2AT
- Temperature: -20 to +70°C
- Connector: 3 Pin Phoenix Mini Combicon connector (Front access)
- Alarm Interface: Major and Minor Alarm Relais
- Connector: 6 Pin Phoenix Mini Combicon connector (Front access)
- Size: 110x181x88mm (WxLxH)



### MiniFlex MiniRack Wallmount Kit

**Model:** MF-MR-RAIL-WALLMOUNT,V1



### MiniFlex Dual Unit for 2 Linecards

**Model:** MF-DU-RAIL-2U2S-24V, V2  
MF-DU-RAIL-2U2S-230V, V2

- Input Voltage DC: 18 - 72 VDC, max. 20 Watts without PoE
- Input Voltage AC: 85-264VAC, 120-370VDC, max 20 Watts without PoE
- Temperature: -40 to +70°C
- Connector: 3 Pin Phoenix Mini Combicon connector (Bottom access)
- Alarm Interface: Major and Minor Alarm Relais
- Connector: 6 Pin Phoenix Mini Combicon connector (Bottom access)
- Size: 50x180x87mm (WxLxH)



## MiniFlex SHDSL.bis Line Card



### Model: MF-PAM-SR2L-2Eth, V1

- DSL Version: SHDSL / SHDSL.bis / Extended
- Modulation: TC-PAM4 / TC-PAM8 / TC-PAM16 / TC-PAM32 / TC-PAM64 / TC-PAM128
- Data Rate: 128kbps - 30.464Mbps, 2x 15.232Mbps
- Copper Pairs: 2 with Modes Master / Slave / Auto / Multipoint / Multipair
- Interfaces: 1x Ethernet 10/100BaseT on Backplane to Switch  
2x Ethernet 10/100BaseT on the front panel  
1x USB 2.0 (Local Console Port)
- Physical Interfaces: Phoenix Mini Combicon (SHDSL), RJ45 (Ethernet), Mini-B (USB)
- Management: Console Port, Telnet, SSH, HTTP, HTTPs and SNMPv1/v2c/v3t

## MiniFlex Dual EFM Line Card



### Model: MF-EFM-SR2L-2Eth, V1

- DSL Version: EFM SHDSL / SHDSL.bis / Extended
- Modulation: TC-PAM4 / TC-PAM8 / TC-PAM16 / TC-PAM32 / TC-PAM64 / TC-PAM128
- Data Rate: 128kbps - 30.464Mbps, 2x 15.232Mbps
- Copper Pairs: 2 with Modes Master / Slave / Auto / Multipoint / Bonding
- Interfaces: 1x Ethernet 10/100/1000BaseT on Backplane to Switch  
2x Ethernet 10/100/1000BaseT on the front panel  
1x USB 2.0 (Local Console Port)
- Physical Interfaces: Phoenix Mini Combicon (EFM), RJ45 (Ethernet), Mini-B (USB)
- Management: Console Port, Telnet, SSH, HTTP, HTTPs and SNMPv1/v2c/v3

## MiniFlex Quad EFM Line Card



### Model: MF-EFM-SR4L-2Eth, V1

- DSL Version: EFM SHDSL / SHDSL.bis / Extended
- Modulation: TC-PAM4 / TC-PAM8 / TC-PAM16 / TC-PAM32 / TC-PAM64 / TC-PAM128
- Data Rate: 128kbps - 60.928Mbps, 4x 15.232Mbps
- Copper Pairs: 4 with Modes Master / Slave / Auto / Multipoint / Bonding
- Interfaces: 1x Ethernet 10/100/1000BaseT on Backplane to Switch  
2x Ethernet 10/100/1000BaseT on the front panel  
1x USB 2.0 (Local Console Port)
- Physical Interfaces: Phoenix Combicon DMC (EFM), RJ45 (Ethernet), Mini-B (USB)
- Management: Console Port, Telnet, SSH, HTTP, HTTPs and SNMPv1/v2c/v3t

## MiniFlex SHDSL.bis BYPASS Line Card



### Model: MF-BYP-SR2L, V1

- Copper Pairs: Bypass for 2 copper pairs (2xSHDSL to 2xSHDSL)
- Physical Interfaces: Phoenix Mini Combicon (SHDSL)
- Management: Bypass On/Off switch



### MiniFlex Single Fiber Optic Line Card

**Model: MF-FOM-SRL, V1**

- Fiber Optic: 100Base-FX
- Data Rate: 100 Mbps
- Line Budget: Dependent on SFP module type
- Number of Fiber: 1 or 2, depending on the SFP module type
- Modes: Auto
- Interfaces: 1x Ethernet 10/100BaseT on Backplane to Switch  
1x Ethernet 100Base-FX (SFP) on the front panel  
1x USB 2.0 (Local Console Port)
- Physical Interfaces: SFP cage, Backplane (Ethernet), Mini-B (USB)
- Management: Console Port, Telnet, SSH, HTTP, HTTPs and SNMPv1/v2c/v3t



### MiniFlex Dual Fiber Optic Line Card

**Model: MF-FOM-SR2L-2Eth, V1**

- Fiber Optic: 100Base-FX
- Data Rate: 100 Mbps
- Line Budget: Dependent on SFP module type
- Number of Fiber: 1 or 2, depending on the SFP module type
- Modes: Auto
- Interfaces: 1x Ethernet 10/100BaseT on Backplane to Switch  
2x Ethernet 10/100BaseT on the front panel  
2x Ethernet 100Base-FX (SFP) on the front panel  
1x USB 2.0 (Local Console Port)
- Physical Interfaces: SFP cage, RJ45 (Ethernet), Mini-B (USB)
- Management: Console Port, Telnet, SSH, HTTP, HTTPs and SNMPv1/v2c/v3t



### MiniFlex Dual Giga Fiber Optic Line Card

**Model: MF-GFOM-SR2L-2Eth, V1**

- Fiber Optic: 100Base-FX / 1000Base-X
- Data Rate: 100 / 1000 Mbps
- Line Budget: Dependent on SFP module type
- Number of Fiber: 1 or 2, depending on the SFP module type
- Modes: Auto
- Interfaces: 1x Ethernet 10/100/1000BaseT on Backplane to Switch  
2x Ethernet 10/100/1000BaseT on the front panel  
2x Ethernet 100Base-FX or 1000Base-X (SFP) on the front panel  
1x USB 2.0 (Local Console Port)
- Physical Interfaces: SFP cage, RJ45 (Ethernet), Mini-B (USB)
- Management: Console Port, Telnet, SSH, HTTP, HTTPs and SNMPv1/v2c/v3t



### MiniFlex POE (Power over Ethernet) Line Card

**Model: MF-POE-SRL-2Eth, V1**

- Ethernet: IEEE-802.3
- Modes: MDI / MDI-X auto crossover, Auto Negotiation, Full/Half Duplex
- PoE: IEEE 802.3af, 15.4Watts
- PoE Modes: Mode A or Mode B, Jumper settings
- Interfaces: 2x Ethernet 10/100BaseT on Backplane to Switch  
2x Ethernet (with PoE) 10/100BaseT on the front panel
- Physical Interfaces: RJ45 (Ethernet)
- Management: No



## MiniFlex Managed Switch Line Card



### Model: MF-SW-SRL-8Eth, V1

Ethernet: IEEE-802.3, VLAN IEEE-802.1Q, QoS IEEE-802.1P  
Modes: MDI / MDI-X auto crossover, Auto Negotiation, Full/Half Duplex  
Interfaces: 4x Ethernet 10/100BaseT on Backplane to Switch/other cards  
4x Ethernet 10/100BaseT on the front panel  
1x USB 2.0 (Local Consol Port)

Physical Interfaces: RJ45 (Ethernet), Mini-B (USB)  
Management: Console Port, Telnet, SSH, HTTP, HTTPS and SNMPv1/v2c/v3t

## MiniFlex Managed Gigabit Ethernet Switch Line Card



### Model: MF-GSW-SRL-8Eth, V1

Ethernet: IEEE-802.3, VLAN IEEE-802.1Q, QoS IEEE-802.1P  
Modes: MDI / MDI-X auto crossover, Auto Negotiation, Full/Half Duplex  
Interfaces: 4x Ethernet 10/100/1000 BaseT on Backplane to Switch/other cards  
4x Ethernet 10/100/1000 BaseT on the front panel  
1x USB 2.0 (Local Consol Port)

Physical Interfaces: RJ45 (Ethernet), Mini-B (USB)  
Management: Console Port, Telnet, SSH, HTTP, HTTPS and SNMPv1/v2c/v3t

## MiniFlex Serial Interfaces Line Card



### Model: MF-SER-SRL-4V24, V1

Serial: RS-232, V.24/28  
Interfaces: 1x Ethernet 10/100BaseT on Backplane to Switch  
4x RS-232 (V.24/28) on the front panel  
1x USB 2.0 (Local Consol Port)

Physical Interfaces: RJ45 (RS-232), Mini-B (USB)  
Management: Console Port, Telnet, SSH, HTTP, HTTPS and SNMPv1/v2c/v3t

## MiniFlex Dual Fiber Optic Serial Interface Line Card



### Model: MF-FOM-SR2L-SER/Eth, V1

Fiber Optic: 100Base-FX  
Data Rate: 100 Mbps  
Line Budget: Dependent on SFP module type  
Number of Fiber: 1 or 2, depending on the SFP module type  
Modes: Auto  
Interfaces: 1x Ethernet 10/100BaseT on Backplane to Switch  
1x RS-232/422/485 on the front panel  
1x Ethernet 10/100BaseT on the front panel  
2x Ethernet 100Base-FX (SFP) on the front panel  
1x USB 2.0 (Local Consol Port)

Physical Interfaces: SFP cage, RJ45 (RS-232/422/485), RJ45 (Ethernet), Mini-B (USB)  
Management: Console Port, Telnet, SSH, HTTP, HTTPS and SNMPv1/v2c/v3t



### MiniFlex E1 Interface Line Card

**Model: MF-TDM-SRL-4E1B, V1**

- Modes: Converter (Ethernet over E1)  
TDMoIP (special SW)
- PWE Protocols: SAToP (RFC4553)  
CESoPSN (RFC5086)  
CESoETH (MEF-8)
- Interfaces: 1x Ethernet 10/100BaseT on Backplane to Switch  
4x E1 (120Ohm) on the front panel  
1x USB 2.0 (Local Consol Port)
- Physical Interfaces: RJ45 (E1), Mini-B (USB)
- Management: Console Port, Telnet, SSH, HTTP, HTTPs and SNMPv1/v2c/v3t

### MiniFlex VoIP FXS Line Card

**Model: MF-VOIP-SRL-2Eth/2FXS, V1**

- VoIP: RFC3261 SIP: Session Initiation Protocol
- Interfaces: 1x Ethernet 10/100BaseT on Backplane to Switch  
2x FXS on the front panel  
2x Ethernet 10/100BaseT on the front panel  
1x USB 2.0 (Local Consol Port)
- Physical Interfaces: RJ45 (Ethernet), RJ45 (FXS), Mini-B (USB)
- Management: Console Port, Telnet, SSH, HTTP, HTTPs and SNMPv1/v2c/v3t



### MiniFlex VoIP FXO Line Card

**Model: MF-VOIP-SRL-2Eth/2FXO, V1**

- VoIP: RFC3261 SIP: Session Initiation Protocol
- Interfaces: 1x Ethernet 10/100BaseT on Backplane to Switch  
2x FXO on the front panel  
2x Ethernet 10/100BaseT on the front panel  
1x USB 2.0 (Local Consol Port)
- Physical Interfaces: RJ45 (Ethernet), RJ45 (FXO), Mini-B (USB)
- Management: Console Port, Telnet, SSH, HTTP, HTTPs and SNMPv1/v2c/v3t



### MiniFlex VoIP VF Line Card

**Model: MF-VOIP-SRL-2Eth/2VF, V1**

- VoIP: RFC3261 SIP: Session Initiation Protocol
- Interfaces: 1x Ethernet 10/100BaseT on Backplane to Switch  
2x VF (voice frequency + E&M Type 5) on the front panel  
2x Ethernet 10/100BaseT on the front panel  
1x USB 2.0 (Local Consol Port)
- Physical Interfaces: RJ45 (Ethernet), RJ45 (VF), Mini-B (USB)
- Management: Console Port, Telnet, SSH, HTTP, HTTPs and SNMPv1/v2c/v3t

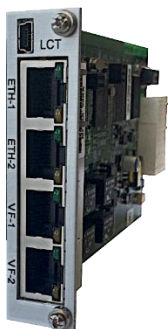

### MiniFlex Input / Output Line Card

**Model: MF-IO-SRL-4I4O/Eth, V1**

- Interfaces: 4 Inputs, 4 Outputs  
1x Ethernet 10/100BaseT on Backplane to Switch  
1x Ethernet 100Base-FX (SFP) on the front panel  
1x USB 2.0 (Local Consol Port)
- Physical Interfaces: DB26F, SFP cage, Mini-B (USB)
- Management: Console Port, Telnet, SSH, HTTP, HTTPs and SNMPv1/v2c/v3t



## MiniFlex SHDSL.bis Dinrail Modem



**Model:** MF-PAM-RAIL2N-2Eth-24V, V1  
MF-PAM-RAIL2N-2Eth-230V, V1  
MF-PAM-RAIL2N-2Eth-24V, V1-PC  
MF-PAM-RAIL2N-2Eth-230V, V1-PC

DSL Version: SHDSL / SHDSL.bis / Extended  
Modulation: TC-PAM4 / TC-PAM8 / TC-PAM16 / TC-PAM32 / TC-PAM64 / TC-PAM128  
Data Rate: 128kbps - 30.464Mbps, 2x 15.232Mbps  
Copper Pairs: 2 with Modes Master / Slave / Auto / Multipoint / Multipair / Ring  
Interface: 2x Ethernet 10/100BaseT (Layer 2 Managed Switch)  
1x USB 2.0 (Local Consol Port)  
Power: 18 to 72VDC or 85 to 264VAC & 120 to 370VDC, 4W Typ.  
Physical Interfaces: RJ45 (Ethernet), Phoenix Mini Combicon (Power & SHDSL), Mini-B (USB)  
Management: Console Port, Telnet, SSH, HTTP, HTTPS, SNMPv1/v2c/v3, SD-Card support  
Temperature: Standard: -5 to +45°C, Extended: -25 to +80°C  
PC-Version: Protective Coating of PCB's against Humidity

## MiniFlex Dual EFM SHDSL.bis Dinrail Modem



**Model:** MF-EFM-RAIL2N-2Eth-24V, V1  
MF-EFM-RAIL2N-2Eth-230V, V1

DSL Version: EFM SHDSL / SHDSL.bis / Extended  
Modulation: TC-PAM4 / TC-PAM8 / TC-PAM16 / TC-PAM32 / TC-PAM64 / TC-PAM128  
Data Rate: 128kbps - 30.464Mbps, 2x 15.232Mbps  
Copper Pairs: 2 with Modes Master / Slave / Auto / Multipoint / Bonding  
Interface: 2x Ethernet 10/100/1000BaseT (Layer 2 Managed Switch)  
1x USB 2.0 (Local Consol Port)  
Power: 18 to 72VDC or 85 to 264VAC & 120 to 370VDC, 4W Typ.  
Physical Interfaces: RJ45 (Ethernet), Phoenix Mini Combicon (Power & SHDSL), Mini-B (USB)  
Management: Console Port, Telnet, SSH, HTTP, HTTPS, SNMPv1/v2c/v3, SD-Card support  
Temperature: Standard: -5 to +45°C, Extended: -25 to +80°C

## MiniFlex Quad EFM SHDSL.bis Dinrail Modem



**Model:** MF-EFM-RAIL4N-2Eth-24V, V1  
MF-EFM-RAIL4N-2Eth-230V, V1

DSL Version: EFM SHDSL / SHDSL.bis / Extended  
Modulation: TC-PAM4 / TC-PAM8 / TC-PAM16 / TC-PAM32 / TC-PAM64 / TC-PAM128  
Data Rate: 128kbps - 60.928Mbps, 4x 15.232Mbps  
Copper Pairs: 4 with Modes Master / Slave / Auto / Multipoint / Bonding  
Interface: 2x Ethernet 10/100/1000BaseT (Layer 2 Managed Switch)  
1x USB 2.0 (Local Consol Port)  
Power: 18 to 72VDC or 85 to 264VAC & 120 to 370VDC, 5W Typ.  
Physical Interfaces: RJ45 (Ethernet), Phoenix Mini Combicon (Power), Phoenix Combicon DMC (EFM SHDSL), Mini-B (USB)  
Management: Console Port, Telnet, SSH, HTTP, HTTPS, SNMPv1/v2c/v3, SD-Card support  
Temperature: Standard: -5 to +45°C, Extended: -25 to +80°C

## MiniFlex Single Fiber Optic Dinrail Modem



**Model:** MF-FOM-RAILN-Eth-24V, V1  
MF-FOM-RAILN-Eth-230V, V1

Fiber Optic: 100Base-FX  
Data Rate: 100 Mbps  
Line Budget: Dependent on SFP module type  
Number of Fiber: 1 or 2, depending on the SFP module type  
Modes: Auto  
Interfaces: 1x Ethernet 10/100BaseT  
1x Ethernet 100Base-FX (SFP)  
1x USB 2.0 (Local Consol Port)  
Power: 18 to 72VDC or 85 to 264VAC & 120 to 370VDC, 4W Typ.  
Physical Interfaces: RJ45 (Ethernet), SFP cage, Mini-B (USB)  
Management: Console Port, Telnet, SSH, HTTP, HTTPS and SNMPv1/v2c/v3  
Temperature: Standard: -5 to +45°C, Extended: -25 to +80°C

## MiniFlex Dual Fiber Optic Dinrail Modem



**Model:** MF-FOM-RAIL2N-2Eth-24V, V1  
MF-FOM-RAIL2N-2Eth-230V, V1

Fiber Optic: 100Base-FX  
Data Rate: 100 Mbps  
Line Budget: Dependent on SFP module type  
Number of Fiber: 1 or 2, depending on the SFP module type  
Modes: Auto  
Interfaces: 2x Ethernet 10/100BaseT  
2x Ethernet 100Base-FX (SFP)  
1x USB 2.0 (Local Consol Port)  
Power: 18 to 72VDC or 85 to 264VAC & 120 to 370VDC, 5W Typ.  
Physical Interfaces: RJ45 (Ethernet), SFP cage, Mini-B (USB)  
Management: Console Port, Telnet, SSH, HTTP, HTTPs, SNMPv1/v2c/v3, SD-Card support  
Temperature: Standard: -5 to +45°C, Extended: -25 to +80°C

## MiniFlex Dual Giga Fiber Optic Dinrail Modem



**Model:** MF-GFOM-RAIL2N-2Eth-24V, V1  
MF-GFOM-RAIL2N-2Eth-230V, V1

Fiber Optic: 100Base-FX or 1000Base-X  
Data Rate: 100 / 1000 Mbps  
Line Budget: Dependent on SFP module type  
Number of Fiber: 1 or 2, depending on the SFP module type  
Modes: Auto  
Interfaces: 2x Ethernet 10/100/1000BaseT  
2x Ethernet 100Base-FX or 1000Base-X (SFP)  
1x USB 2.0 (Local Consol Port)  
Power: 18 to 72VDC or 85 to 264VAC & 120 to 370VDC, 5W Typ.  
Physical Interfaces: RJ45 (Ethernet), SFP cage, Mini-B (USB)  
Management: Console Port, Telnet, SSH, HTTP, HTTPs, SNMPv1/v2c/v3, SD-Card support  
Temperature: Standard: -5 to +45°C, Extended: -25 to +80°C

## MiniFlex Managed Switch Dinrail Unit



**Model:** MF-SW-RAIL-4Eth-24V, V1  
MF-SW-RAIL-4Eth-230V, V1

Ethernet: IEEE-802.3, VLAN IEEE-802.1Q, QoS IEEE-802.1P  
Modes: MDI / MDI-X auto crossover, Auto Negotiation, Full/Half Duplex  
Interfaces: 4x Ethernet 10/100BaseT  
Power: 18 to 72VDC or 85 to 264VAC & 120 to 370VDC, 4W Typ.  
Physical Interfaces: RJ45 (Ethernet), Mini-B (USB)  
Management: Console Port, Telnet, SSH, HTTP, HTTPs and SNMPv1/v2c/v3  
Temperature: Standard: -5 to +45°C, Extended: -25 to +80°C

## MiniFlex Gigabit Ethernet Managed Switch Dinrail Unit



**Model:** MF-GSW-RAIL-4Eth-24V, V1  
MF-GSW-RAIL-4Eth-230V, V1

Ethernet: IEEE-802.3, VLAN IEEE-802.1Q, QoS IEEE-802.1P  
Modes: MDI / MDI-X auto crossover, Auto Negotiation, Full/Half Duplex  
Interfaces: 4x Ethernet 10/100/1000BaseT  
Power: 18 to 72VDC or 85 to 264VAC & 120 to 370VDC, 5W Typ.  
Physical Interfaces: RJ45 (Ethernet), Mini-B (USB)  
Management: Console Port, Telnet, SSH, HTTP, HTTPs and SNMPv1/v2c/v3  
Temperature: Standard: -5 to +45°C, Extended: -25 to +80°C



## MiniFlex POE (Power over Ethernet) Dinrail Unit



### Model: MF-POE-RAILN-Eth-24V, V1

|                      |  |
|----------------------|--|
| Ethernet:            | IEEE-802.3, VLAN IEEE-802.1Q, QoS IEEE-802.1P                  |
| Modes:               | MDI / MDI-X auto crossover, Auto Negotiation, Full/Half Duplex |
| PoE:                 | IEEE 802.3af, 15.4Watts  |
| PoE Modes:           | Mode A or Mode B, Jumper settings                              |
| Interfaces:          | 1x Ethernet 10/100BaseT  |
|                      | 1x Ethernet (with PoE) 10/100BaseT                             |
| Power:               | 18 to 72VDC, max 25W   |
| Physical Interfaces: | RJ45 (Ethernet)  |
| Management:          | No   |
| Temperature:         | Standard: -5 to +45°C, Extended: -25 to +80°C                  |

## MiniFlex Dual Fiber Optic Serial Interface Dinrail Modem



### Model: MF-FOM-RAIL2N-SER/Eth-24V, V1 MF-FOM-RAIL2N-SER/Eth-230V, V1

|                      |  |
|----------------------|--|
| Fiber Optic:         | 100Base-FX   |
| Data Rate:           | 100 Mbps   |
| Line Budget:         | Dependent on SFP module type                                   |
| Number of Fiber:     | 1 or 2, depending on the SFP module type                       |
| Modes:               | Auto   |
| Interfaces:          | 1x Ethernet 10/100BaseT  |
|                      | 1x RS-232/422/485  |
|                      | 2x Ethernet 100Base-FX (SFP)                                   |
|                      | 1x USB 2.0 (Local Consol Port)                                 |
| Power:               | 18 to 72VDC or 85 to 264VAC & 120 to 370VDC, 5W Typ.           |
| Physical Interfaces: | RJ45 (Ethernet), RJ45 (RS-232/422/485), SFP cage, Mini-B (USB) |
| Management:          | Console Port, Telnet, SSH, HTTP, HTTPs and SNMPv1/v2c/v3       |
| Temperature:         | Standard: -5 to +45°C, Extended: -25 to +80°C                  |

## MiniFlex Dual Fiber Optic Serial Interface Dinrail Modem



### Model: MF-FOM-RAIL2N-2V24-24V, V1 MF-FOM-RAIL2N-2V24-230V, V1

|                      |  |
|----------------------|--|
| Fiber Optic:         | 100Base-FX   |
| Data Rate:           | 100 Mbps   |
| Line Budget:         | Dependent on SFP module type                             |
| Number of Fiber:     | 1 or 2, depending on the SFP module type                 |
| Modes:               | Auto   |
| Interfaces:          | 2x RS-232 (V.24/28)                                      |
|                      | 2x Ethernet 100Base-FX (SFP)                             |
|                      | 1x USB 2.0 (Local Consol Port)                           |
| Power:               | 18 to 72VDC or 85 to 264VAC & 120 to 370VDC, 5W Typ.     |
| Physical Interfaces: | RJ45 (RS-232), SFP cage, Mini-B (USB)                    |
| Management:          | Console Port, Telnet, SSH, HTTP, HTTPs and SNMPv1/v2c/v3 |
| Temperature:         | Standard: -5 to +45°C, Extended: -25 to +80°C            |

## MiniFlex E1 Interface Dinrail Unit



### Model: MF-TDM-RAILN-4E1B/2Eth-24V, V1 MF-TDM-RAILN-4E1B/2Eth-230V, V1

|                      |  |
|----------------------|--|
| Modes:               | Converter (Ethernet over E1)<br>TDMoIP (special SW)      |
| PWE Protocols:       | SAToP (RFC4553)<br>CESoPSN (RFC5086)<br>CESoETH (MEF-8)  |
| Interfaces:          | 2x Ethernet 10/100BaseT                                  |
|                      | 4x E1 (120Ohm)   |
|                      | 1x USB 2.0 (Local Consol Port)                           |
| Physical Interfaces: | RJ45 (Ethernet), RJ45 (E1), Mini-B (USB)                 |
| Power:               | 18 to 72VDC or 85 to 264VAC & 120 to 370VDC, 4W Typ.     |
| Management:          | Console Port, Telnet, SSH, HTTP, HTTPs and SNMPv1/v2c/v3 |
| Temperature:         | Standard: -5 to +45°C, Extended: -25 to +80°C            |

## MiniFlex VoIP FXS Dinrail Unit



**Model:** MF-VOIP-RAILN-2Eth/2FXS-24V, V1  
MF-VOIP-RAILN-2Eth/2FXS-230V, V1

**VoIP:** RFC3261 SIP: Session Initiation Protocol  
**Interfaces:** 2x FXS  
2x Ethernet 10/100BaseT  
1x USB 2.0 (Local Console Port)  
**Physical Interfaces:** RJ45 (Ethernet), RJ45 (FXS), Mini-B (USB)  
**Power:** 18 to 72VDC or 85 to 264VAC & 120 to 370VDC, 6W Max.  
**Management:** Console Port, Telnet, SSH, HTTP, HTTPS and SNMPv1/v2c/v3  
**Temperature:** Standard: -5 to +45°C, Extended: -25 to +80°C

## MiniFlex VoIP FXO Dinrail Unit



**Model:** MF-VOIP-RAILN-2Eth/2FXO-24V, V1  
MF-VOIP-RAILN-2Eth/2FXO-230V, V1

**VoIP:** RFC3261 SIP: Session Initiation Protocol  
**Interfaces:** 2x FXO  
2x Ethernet 10/100BaseT  
1x USB 2.0 (Local Console Port)  
**Physical Interfaces:** RJ45 (Ethernet), RJ45 (FXO), Mini-B (USB)  
**Power:** 18 to 72VDC or 85 to 264VAC & 120 to 370VDC, 2W Typ.  
**Management:** Console Port, Telnet, SSH, HTTP, HTTPS and SNMPv1/v2c/v3  
**Temperature:** Standard: -5 to +45°C, Extended: -25 to +80°C

## MiniFlex VoIP VF Dinrail Unit



**Model:** MF-VOIP-RAILN-2Eth/2VF-24V, V1  
MF-VOIP-RAILN-2Eth/2VF-230V, V1

**VoIP:** RFC3261 SIP: Session Initiation Protocol  
**Interfaces:** 2x VF (voice frequency + E&M Type 5)  
2x Ethernet 10/100BaseT  
1x USB 2.0 (Local Console Port)  
**Physical Interfaces:** RJ45 (Ethernet), RJ45 (VF), Mini-B (USB)  
**Power:** 18 to 72VDC or 85 to 264VAC & 120 to 370VDC, 4.4W Max.  
**Management:** Console Port, Telnet, SSH, HTTP, HTTPS and SNMPv1/v2c/v3  
**Temperature:** Standard: -5 to +45°C, Extended: -25 to +80°C

## MiniFlex Input / Output Dinrail Unit



**Model:** MF-IO-RAILN-4I4O/Eth-24V, V1  
MF-IO-RAILN-4I4O/Eth-230V, V1

**Interfaces:** 4 Inputs, 4 Outputs  
1x Ethernet 10/100BaseT on the front panel  
1x USB 2.0 (Local Console Port)  
**Physical Interfaces:** DB26F, RJ45 (Ethernet), Mini-B (USB)  
**Power:** 18 to 72VDC or 85 to 264VAC & 120 to 370VDC, 4.4W Max.  
**Management:** Console Port, Telnet, SSH, HTTP, HTTPS and SNMPv1/v2c/v3  
**Temperature:** Standard: -5 to +45°C, Extended: -25 to +80°C





### MiniFlex Dinrail Wallmount Kit

Model: MF-RAILN-WALLMOUNT, V1

### MiniFlex Comfortable Dinrail Clips

Model: FG-RAIL-ComfortClip-MF

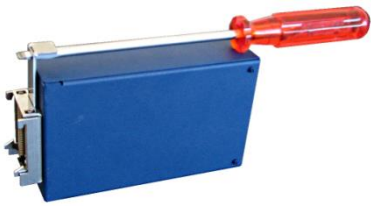

Model: FG-RAIL-ComfortClip-MFMR

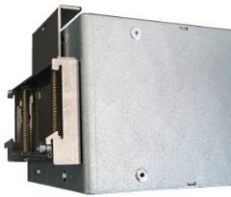

### MiniFlex 19" Installation

Model: FG-RAIL-MRN-1U







Model: FG-RAIL-R-2U







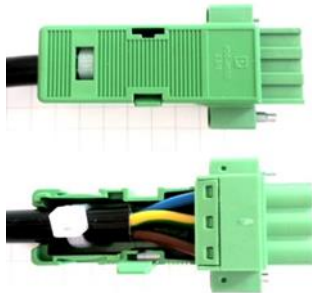

### MiniFlex AC Power Cables for RAIL Units

| Model  | Connector A   | Connector B                | Length |
|--|---|----------------------------|--------|
| FG-CAB-Power-MiniFlex-TypF<br>(Europe)         | CEE 7/7<br>   | 1805314*<br>1803947(case)* | ~1.8m  |
| FG-CAB-Power-MiniFlex-TypG<br>(United Kingdom) | BS 1363<br>   | 1805314*<br>1803947(case)* | ~1.8m  |
| FG-CAB-Power-MiniFlex-TypI<br>(Australia)      | AS 3112<br>   | 1805314*<br>1803947(case)* | ~1.8m  |
| FG-CAB-Power-MiniFlex-TypJ<br>(Switzerland)    | SEV 1011<br>  | 1805314*<br>1803947(case)* | ~1.8m  |
| FG-CAB-Power-MiniFlex-TypL<br>(Italy)          | CEI 23-50<br> | 1805314*<br>1803947(case)* | ~1.8m  |



### MiniFlex AC Power Cables for FlatRack

| Model  | Connector A   | Connector B                | Length |
|--|---|----------------------------|--------|
| FG-CAB-Power-FlatRack-TypF<br>(Europe)         | CEE 7/7<br>   | 1777992*<br>1803947(case)* | ~1.8m  |
| FG-CAB-Power-FlatRack-TypG<br>(United Kingdom) | BS 1363<br>   | 1777992*<br>1803947(case)* | ~1.8m  |
| FG-CAB-Power-FlatRack-TypI<br>(Australia)      | AS 3112<br>   | 1777992*<br>1803947(case)* | ~1.8m  |
| FG-CAB-Power-FlatRack-TypJ<br>(Switzerland)    | SEV 1011<br>  | 1777992*<br>1803947(case)* | ~1.8m  |
| FG-CAB-Power-FlatRack-TypL<br>(Italy)          | CEI 23-50<br> | 1777992*<br>1803947(case)* | ~1.8m  |

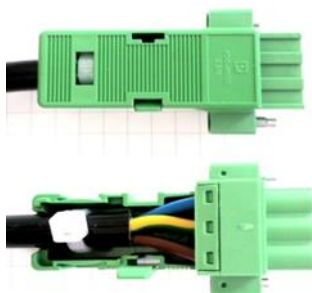

Headquarters: Phoenix, Arizona

Orion Telecom Networks Inc.

20100, N 51st Ave, Suite B240,  
Glendale AZ 85308

E-mail: sales@oriontelecom.com

Website: https://www.oriontelecom.com

Regional Office: Miami, Florida

Orion Telecom Networks Inc.

4000 Ponce de Leon Blvd. Suite 470,  
Coral Gables, FL 33146 U.S.A.

E-mail: sales@oriontelecom.com

Website: https://www.oriontelecom.com